

# Hark 34 GT Ersatzteile

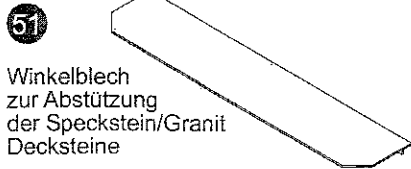

Winkelblech zur Abstützung der Speckstein/Granit Decksteine

Bedienungswerkzeug "Kalte Hand"



Blindeckel mit Dichtung (verschließt Anschlussöffnung Rauchrohrstutzen)

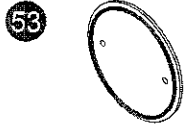

Verbrennungsluftkasten

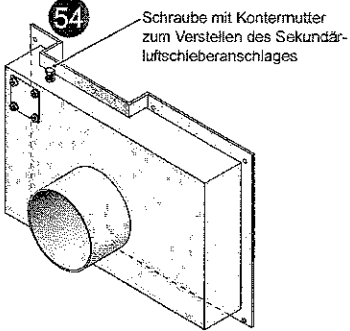

Seriennummer

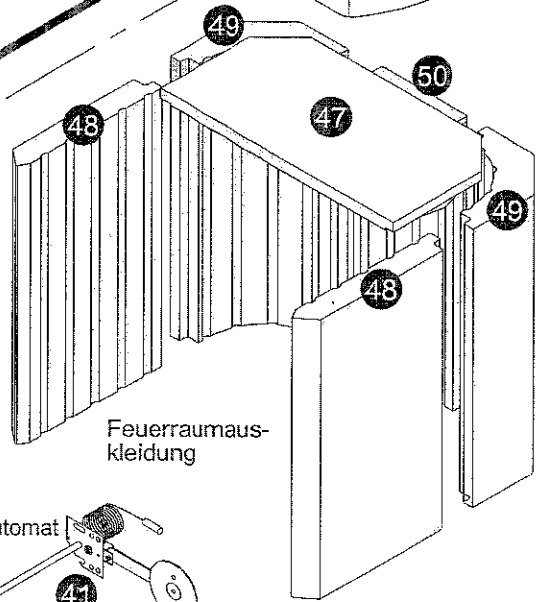
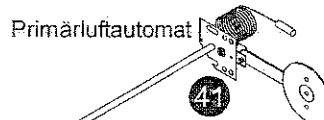
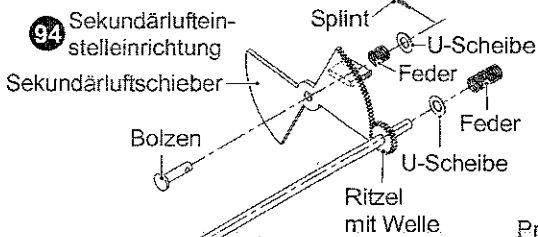
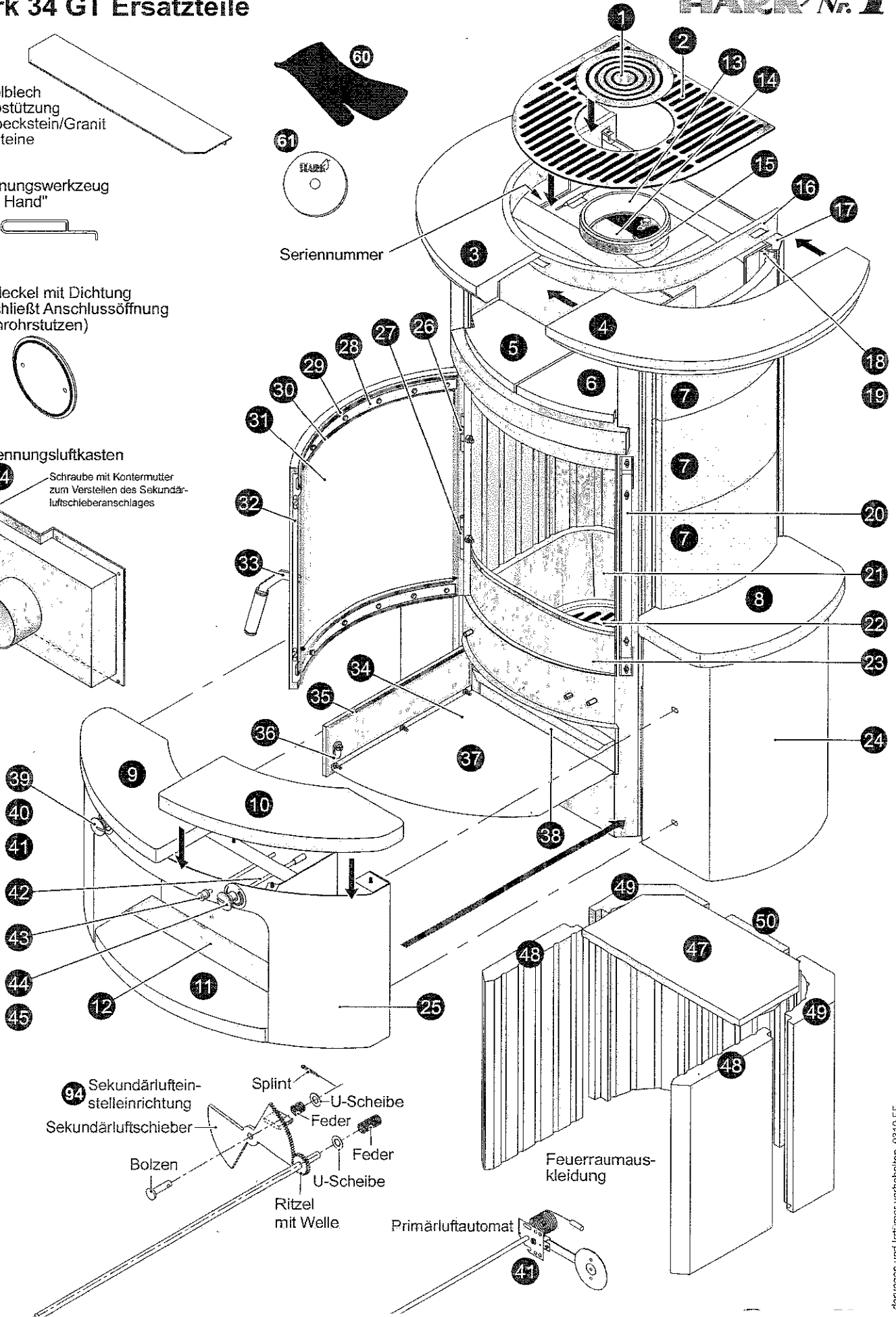

HARK 16

HARK 11

HARK 18 \*

HARK 15

Vorderansicht

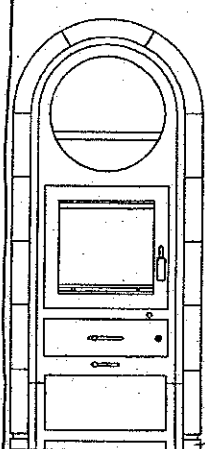
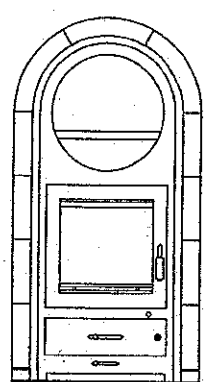
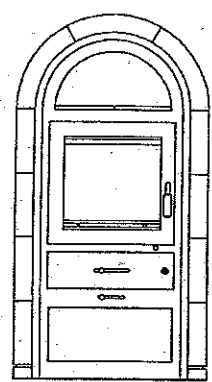
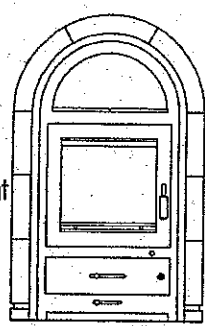

Bodenrahmen

Seitenansicht von links

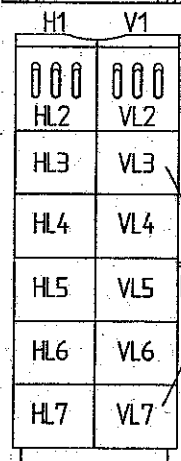
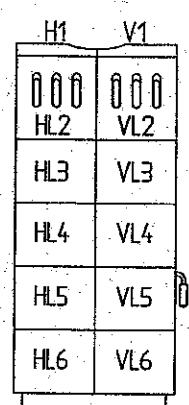
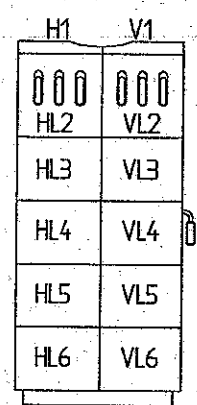
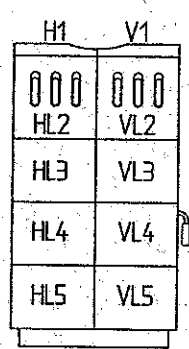

Seitenkacheln

Draufsicht R-Abgang hinten

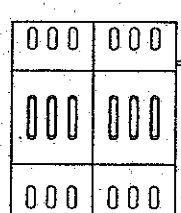
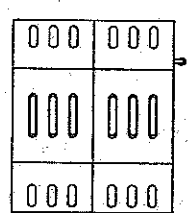
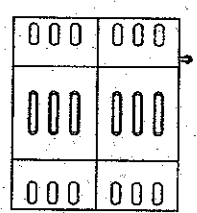
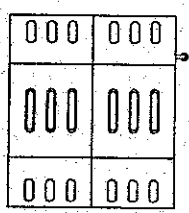

Lüfterkacheln

Draufsicht R-Abgang oben

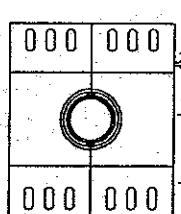
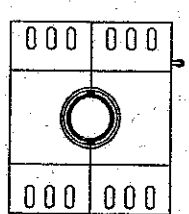
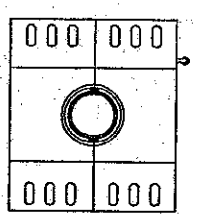
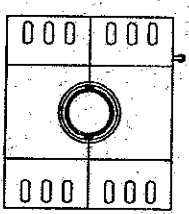

Lüfterkacheln

Deckkacheln

Lüfterkacheln

Draufsicht im Schnitt

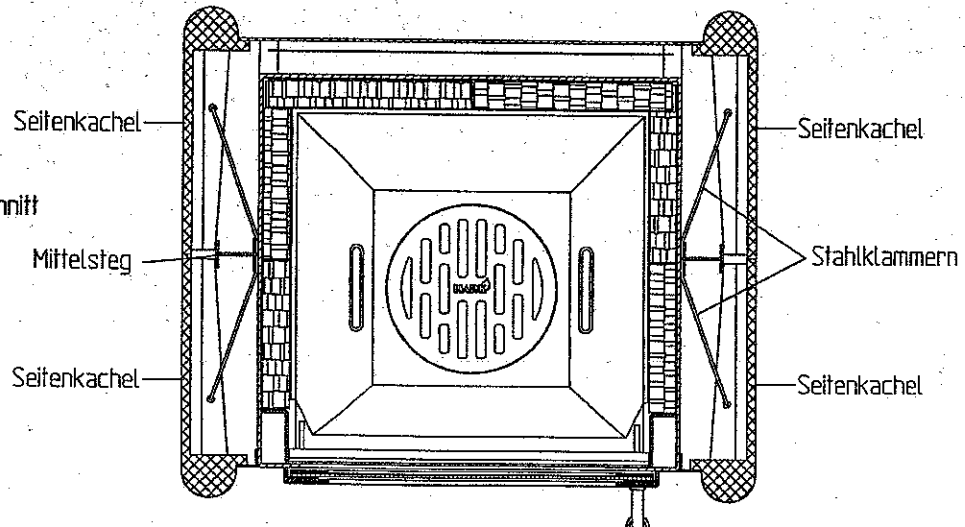

Seitenkachel

Seitenkachel

Mittelsteg

Stahlklammern

Seitenkachel

Seitenkachel

\* Тамълна, укажете котра муфта на зно и пер тегсе какава кафел вам нужна. Спасибо...