



## Eck-Kamin 57/67/44 lifting doors

Version 4.3



**BRUNNER**<sup>®</sup>  
*made in germany*

Dimension sheet | **Eck-Kamin 57/67/44 lifting doors**

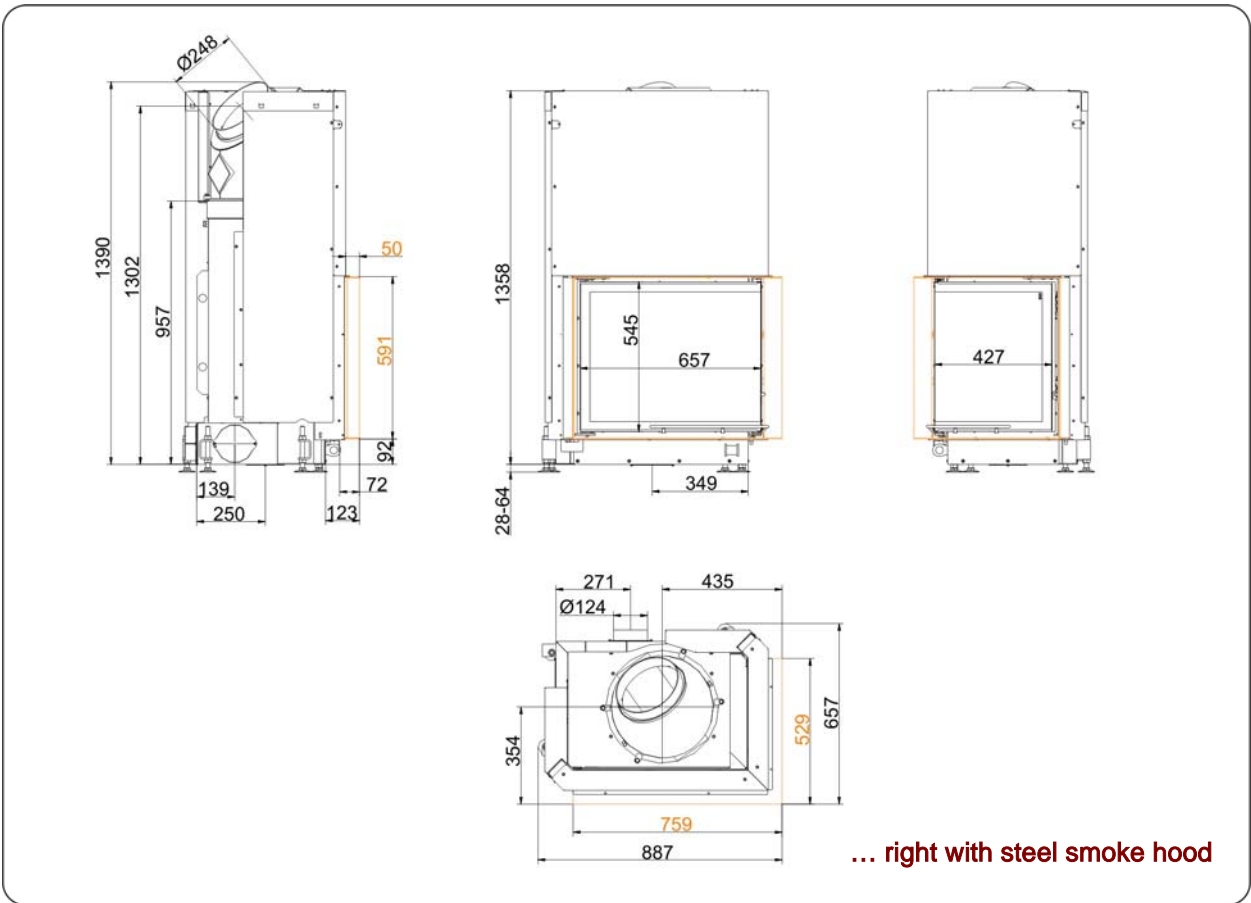
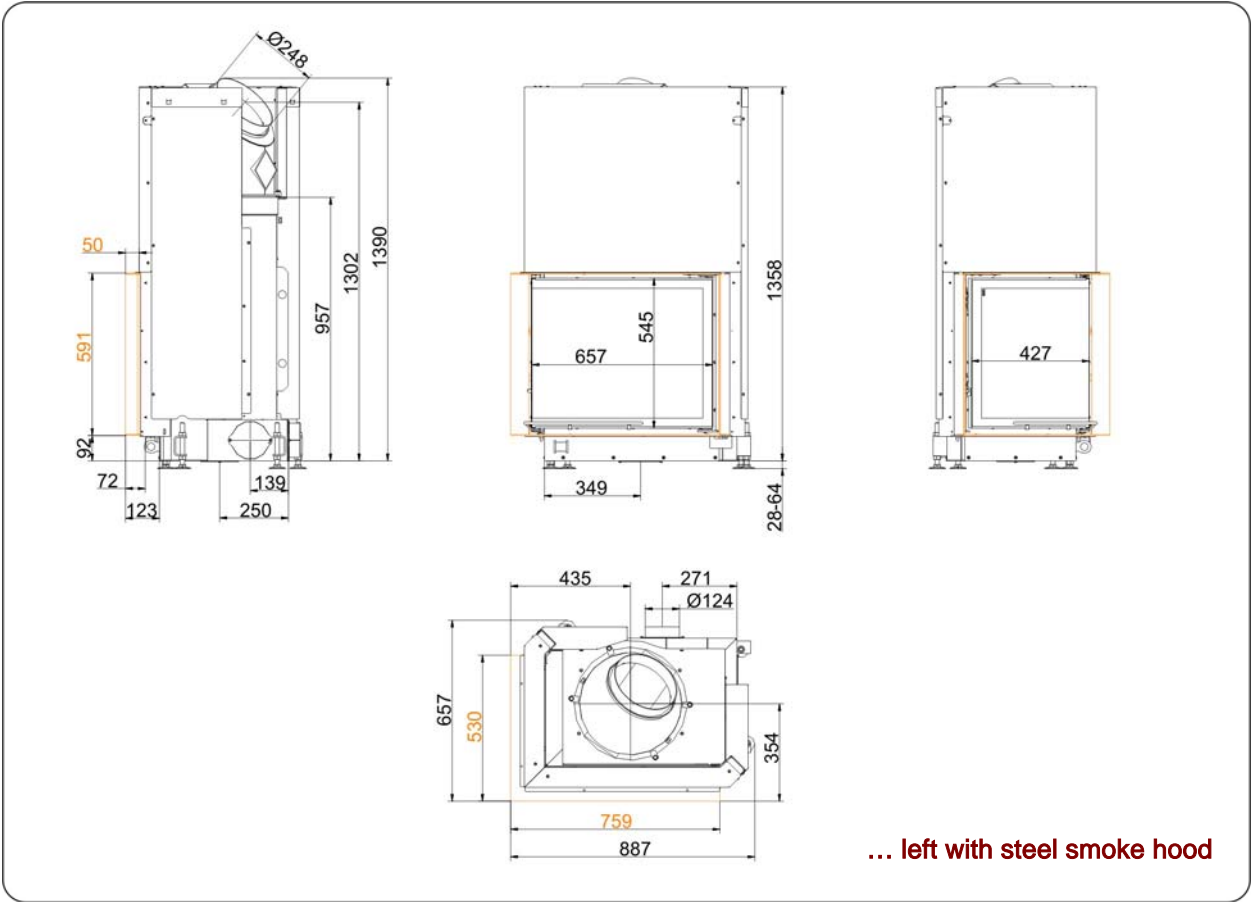

Dimension sheet | **Eck-Kamin 57/67/44 lifting doors**

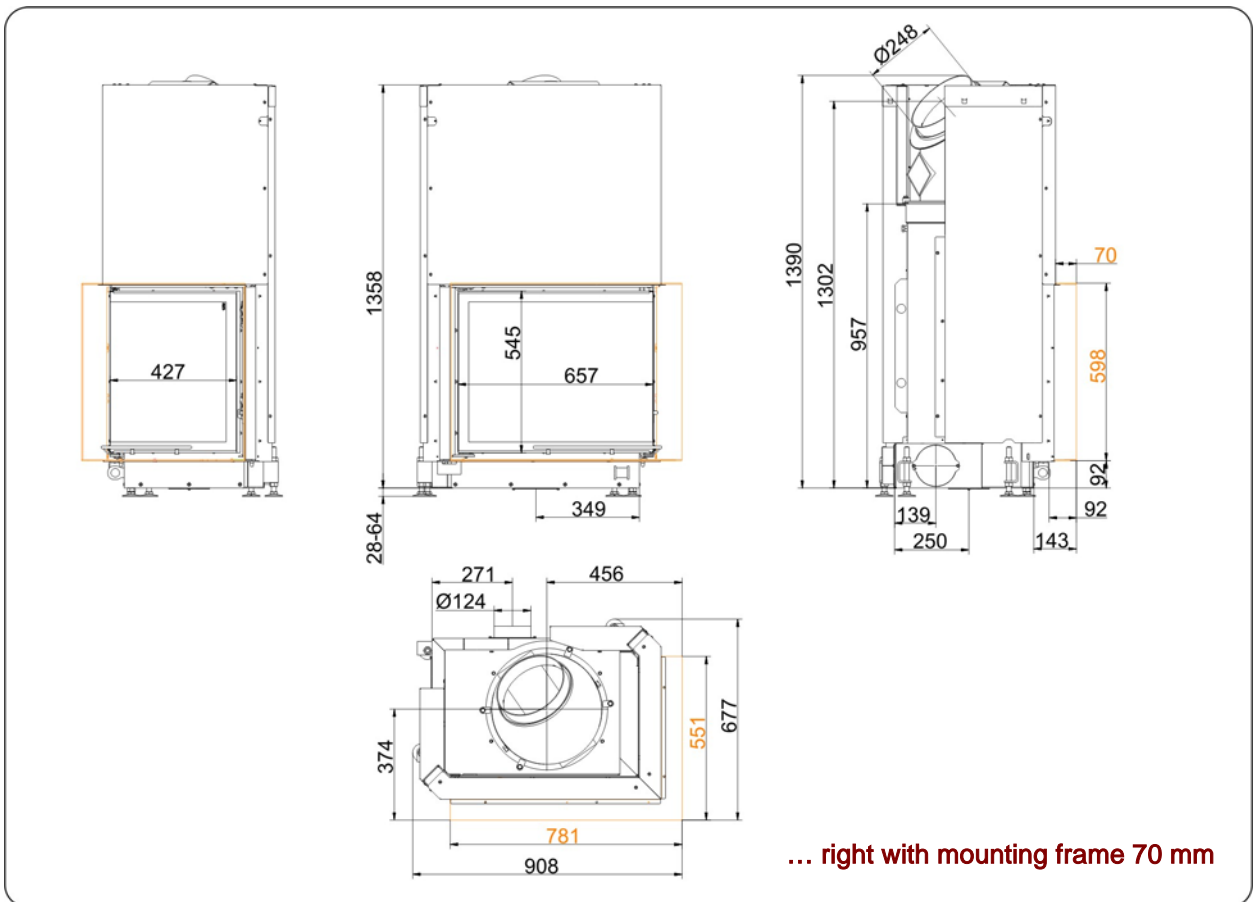
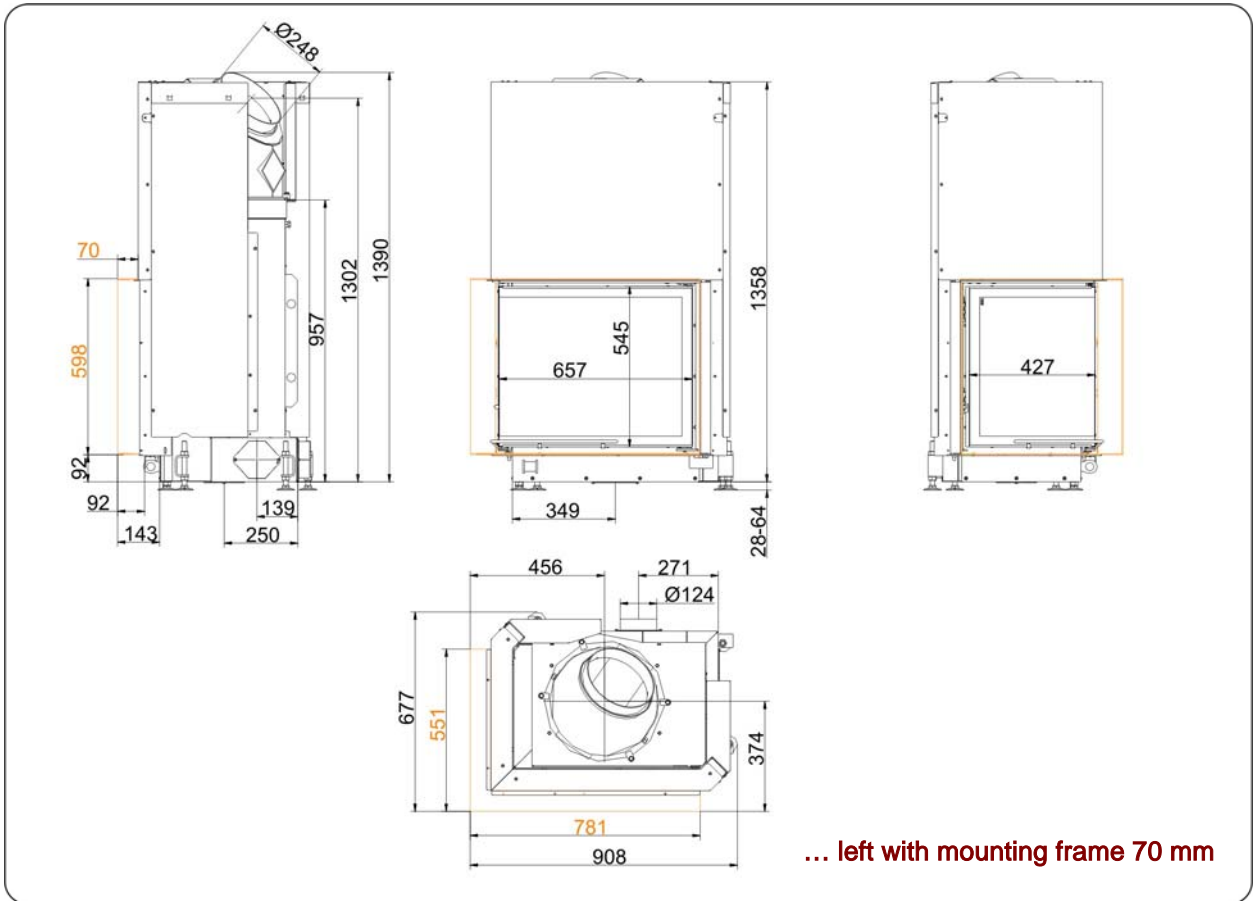

# Planning and installation

## Eck-Kamin 57/67/44

Tested according to		EN 13229 W	EN 13229 WA	EN 13229 W
Values measured at		nominal load	accumulation	open door
Suitable for all construction types according to rules		OK	OK	OK
<b>Data for functional demonstration</b>				
Rated heat power	kW	11	-	-
Firewood consumption	kg/h	3,2	5	3,2
Combustion performance	kW	14	22	14
Flue gas mass flow	g/s	13	19	86
Outlet temperature (before heating surface)	°C	-	330	-
Flue gas temperature after				
attached steel smoke hood	°C	225	255	115
1 x adjoining cast iron radiator (GNF10)	°C	-	151	-
6 x accumulation rings (MAS) <sup>1)</sup>	°C	-	220	-
2 m adjoining ceramic accumulator <sup>2)</sup>	°C	-	-	-
ceramic modular accumulator (KMS system)	°C	-	-	-
water boiler	°C	-	-	-
Necessary supply pressure	Pa	13	15	9
Combustion air consumption	m³/h	32	50	210
Combustion air connection Ø	mm	125	125	-
<b>Heat distribution</b>				
Insert / heating surface	%	25 / 30	25 / 30	- / -
Glass (single / double)	%	45 / -	45 / -	- / -
Boiler	%	-	-	-
<b>Cross-section of gratings for max. warm air power</b>				
Supply air	cm²	1100	1100	0
Warm air	cm²	1100	1100	0
<b>Minimal oven surface for closed construction type</b>				
Surface giving off heat	m²	4,5	4,5	-
<b>Space inside oven chamber</b>				
Distance to oven chamber wall	cm	8	8	8
Distance to floor	cm	15	15	15
<b>Heat insulation without / with <sup>3)</sup> air gratings</b>				
Wall	cm	14 / 10	14 / 10	14 / 10
Floor	cm	2 / 2	2 / 2	2 / 2
Ceiling	cm	19 / 14	19 / 14	19 / 14
Insulation of additional fire door DHT	cm	-	-	-
Brick lining of protected walls	cm	10	10	10
<b>Weight</b>				
Fireplace + burning chamber	kg		190 + 62	
<b>Approvals</b>				
Germany / Austria / Switzerland		1.BImSchV (Stufe 1) / 15a BVG / LRV		

1) Throttle flap recommended

2) Approximate value, must be calculated eventually

3) Values with air gratings, stove casing is heat conducting

Ulrich Brunner GmbH  
 Zellhuber Ring 17 -18  
 D-84307 Eggenfelden  
 Phone: +49 / (0)87 21 / 7 71-0  
 Fax: +49 / (0)87 21 / 7 71-100  
 info@brunner.de | www.brunner.de



BRUNNER products are offered and sold only by qualified dealers and service centres.  
 Subject to technical and assortment changes. Errors excepted. (7/10)